

DOOR INSTALLATION OPTIONS **Garden Sheds**



Neo



HighLine



Panorama



AvantGarde



Europa



QUALITY FROM
A U S T R I A

Illustration of Sidewall Elements



Garden Shed Neo (pg. 4 – 9)

Standard Door

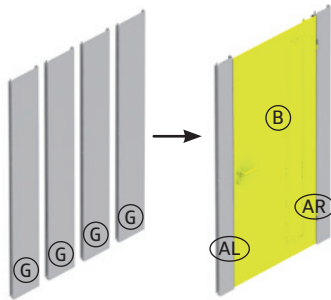

Double Door

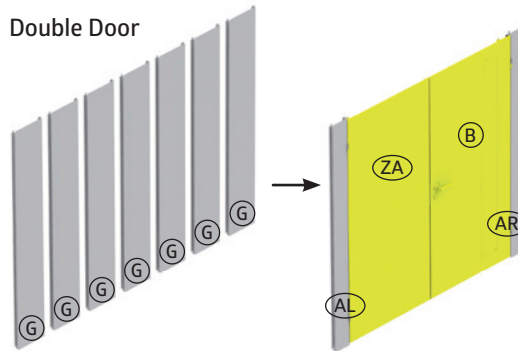

Garden Shed HighLine®, Panorama® (pg. 10 – 11)

Standard Door

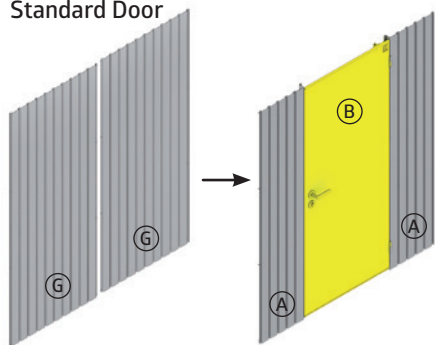

Double Door

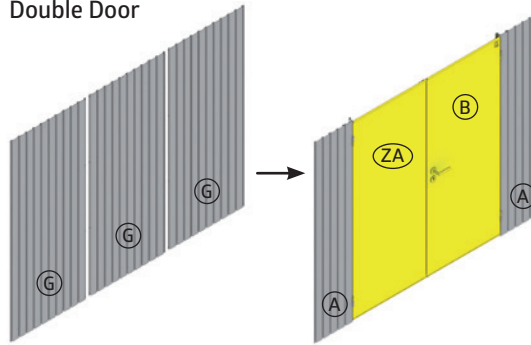
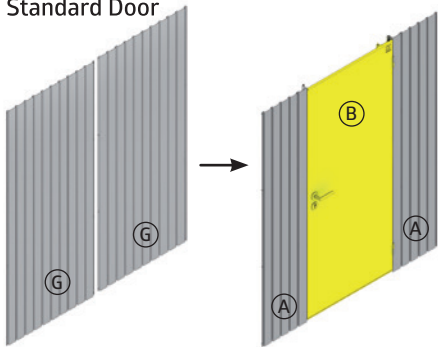

Illustration of Sidewall Elements



Garden Shed AvantGarde® (pg. 12 – 13)

Standard Door



Double Door
A1-A4

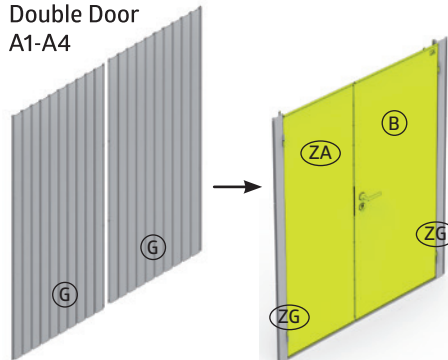

Double Door
A5-A8

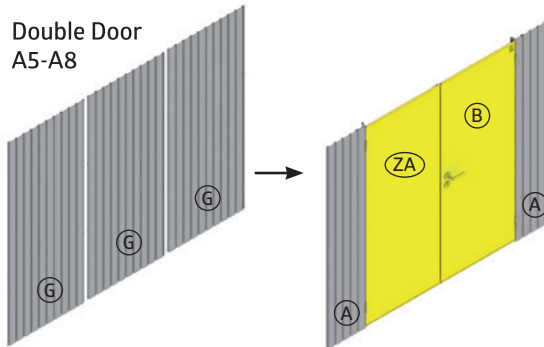

Garden Shed Europa (pg. 14 – 15)

Double Door

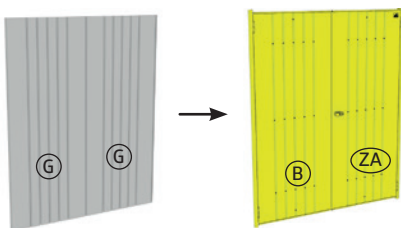

Neo

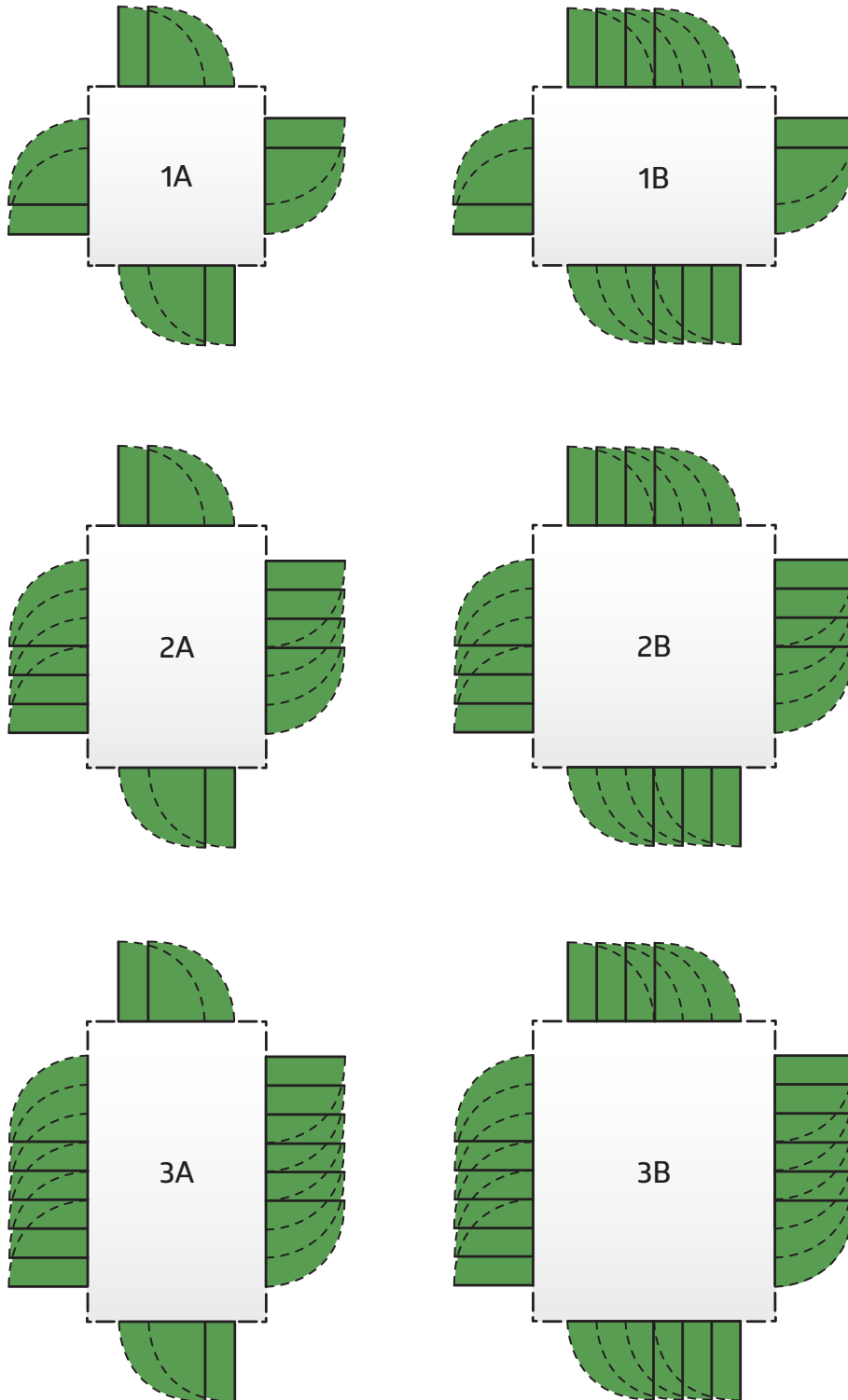

Neo

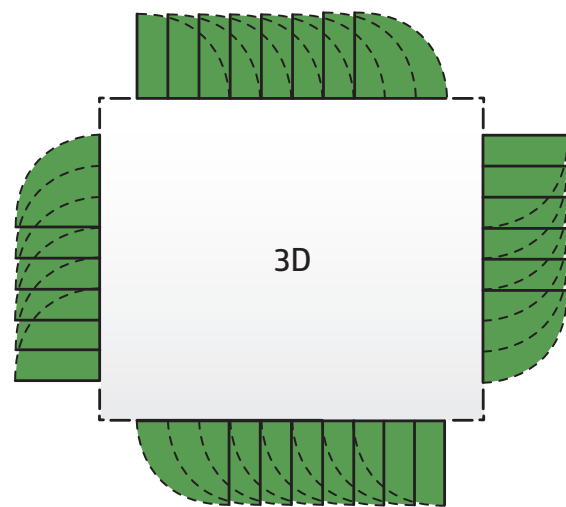
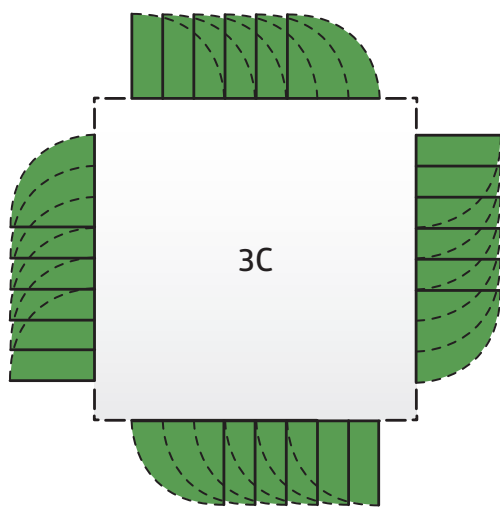
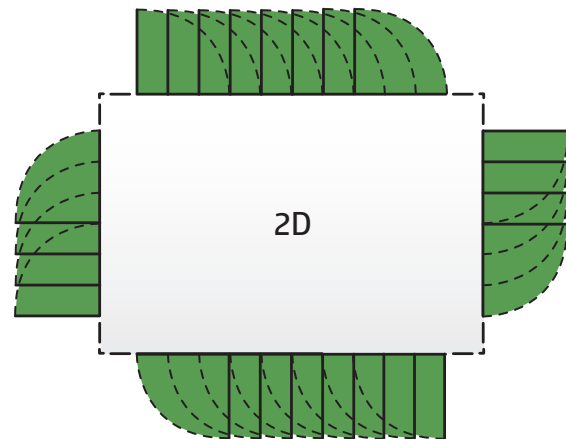
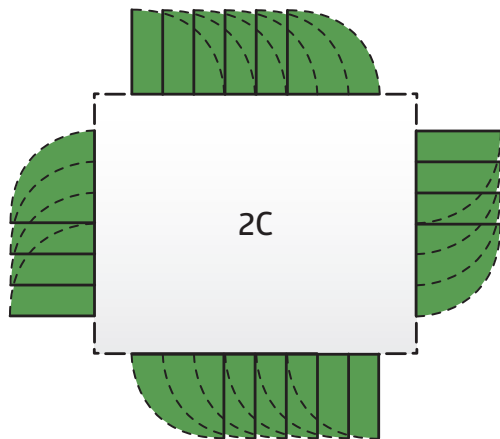
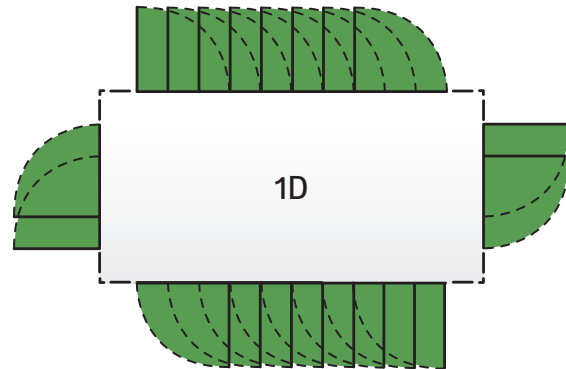
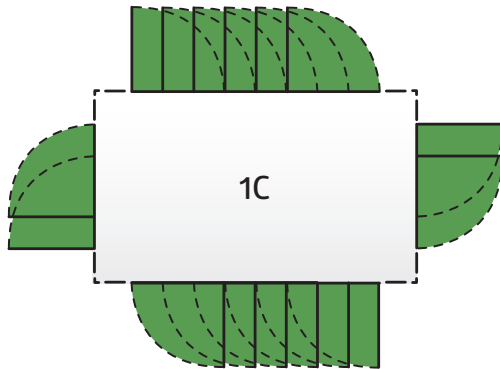

*standard door cannot be installed adjacent to an acrylic glass panel.

Neo

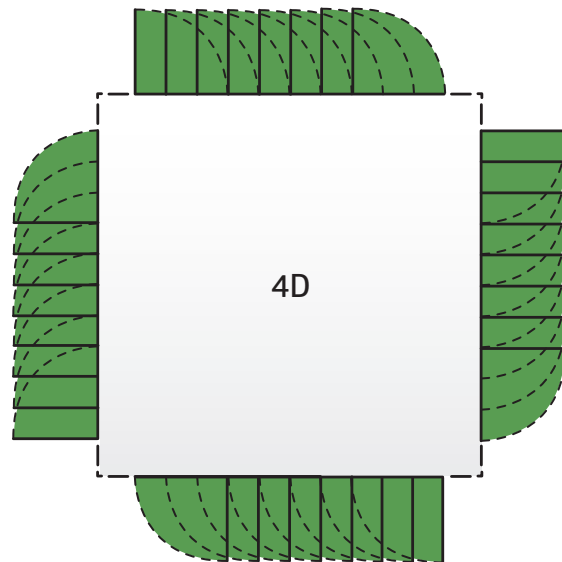
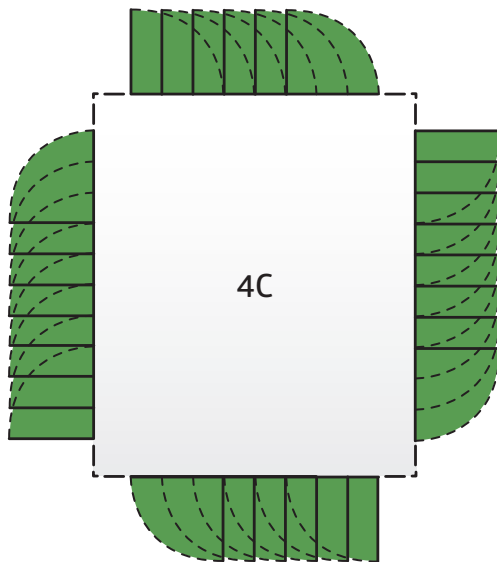
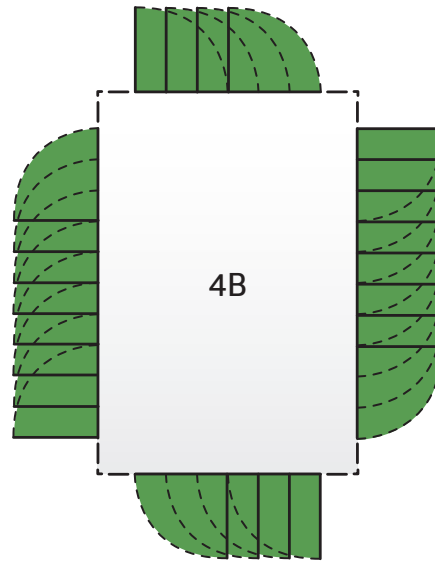
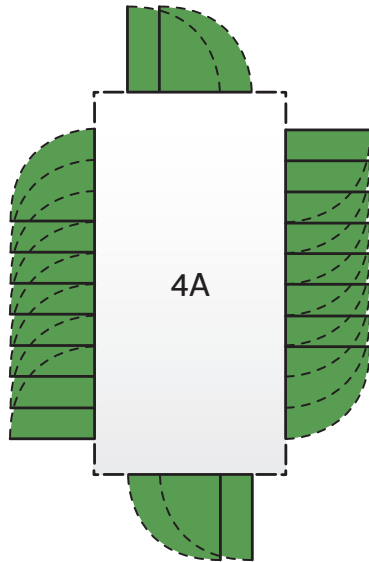

Door Installation Options: Double Door*

Neo

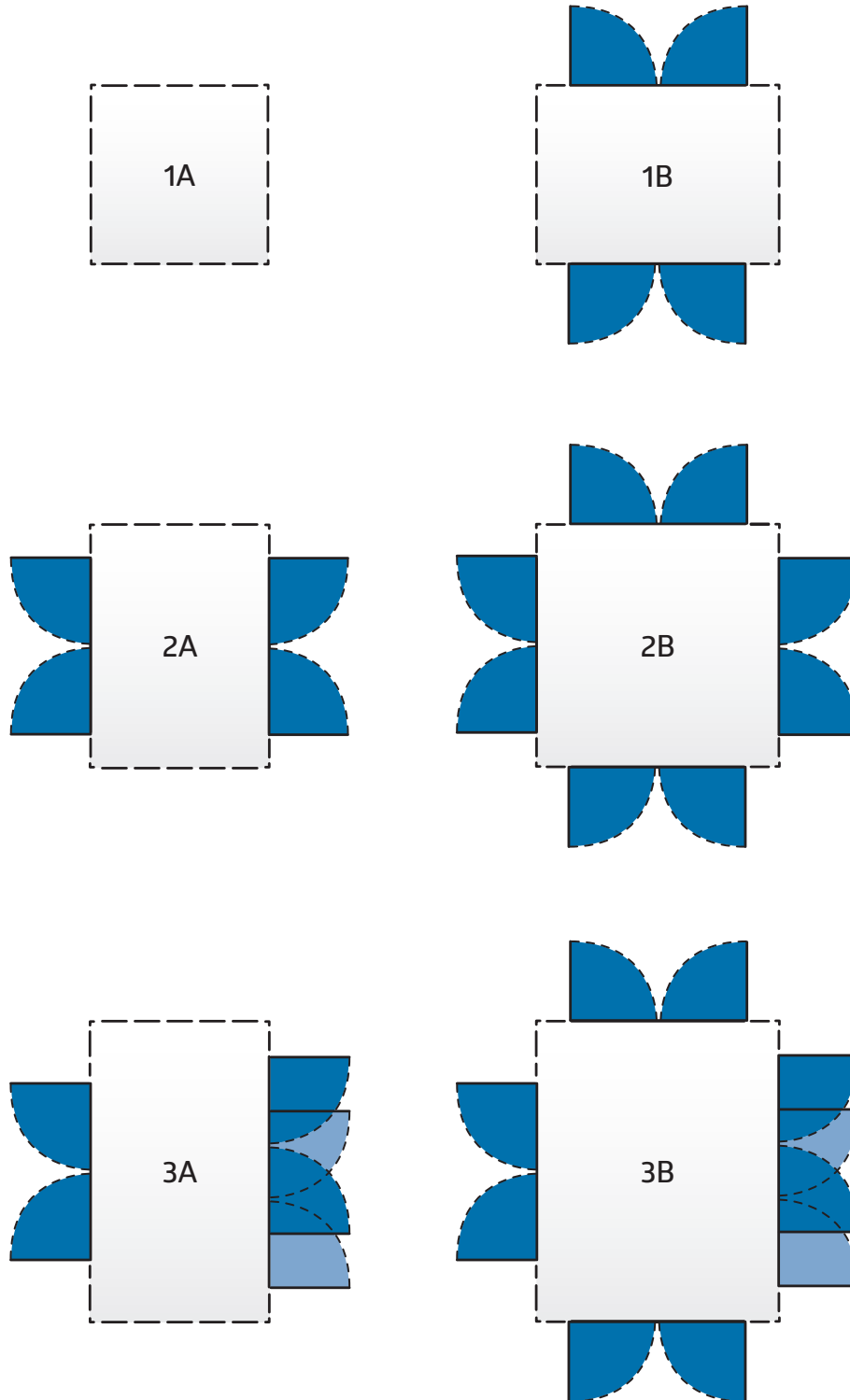

Door Installation Options: Double Door*

Neo

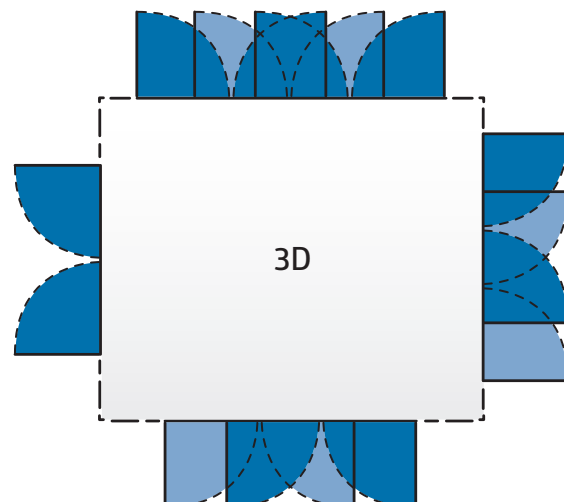
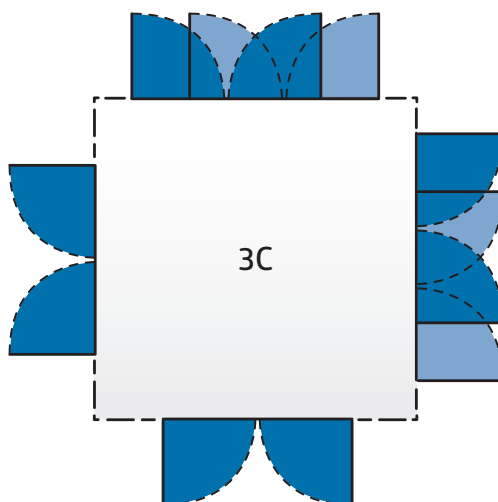
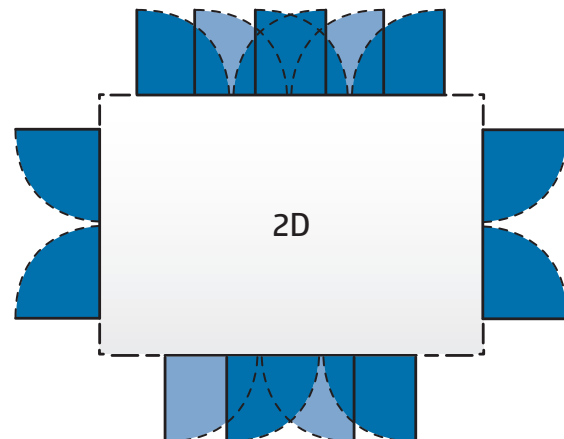
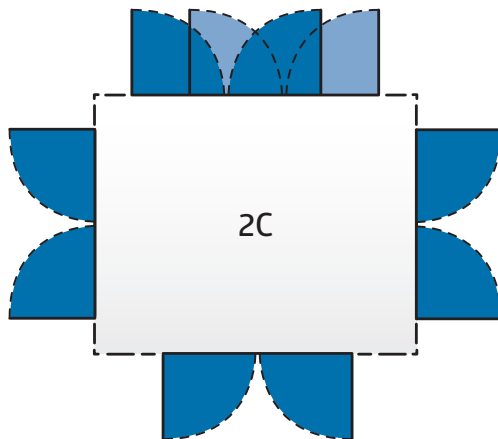
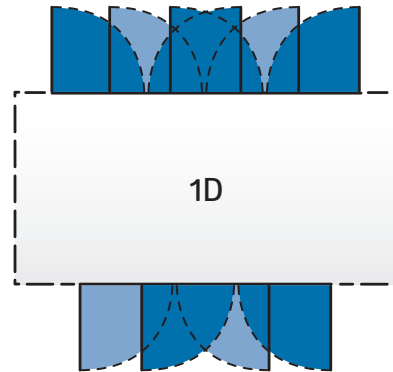
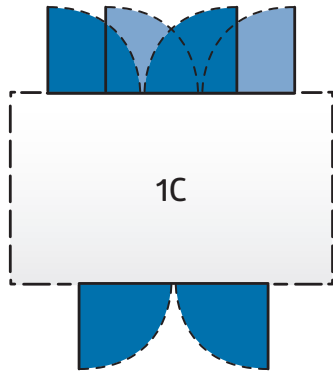

Door Installation Options: Double Door*

Neo

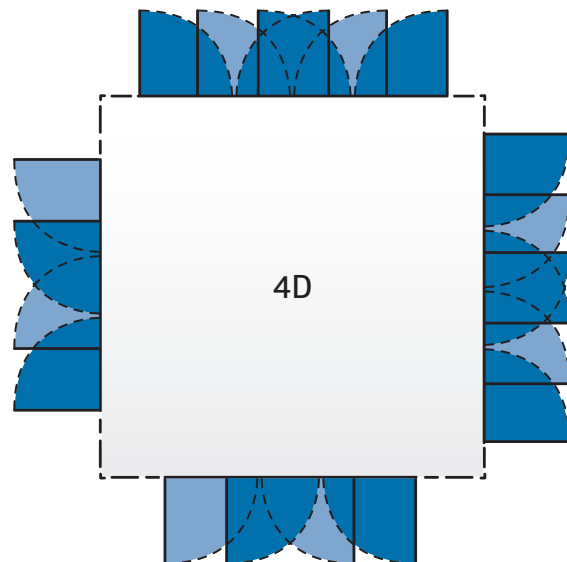
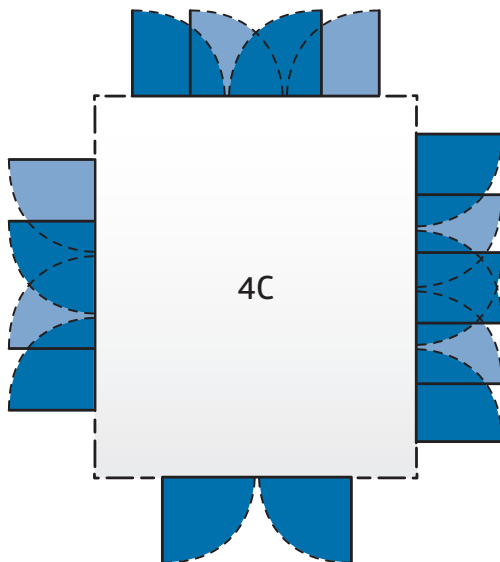
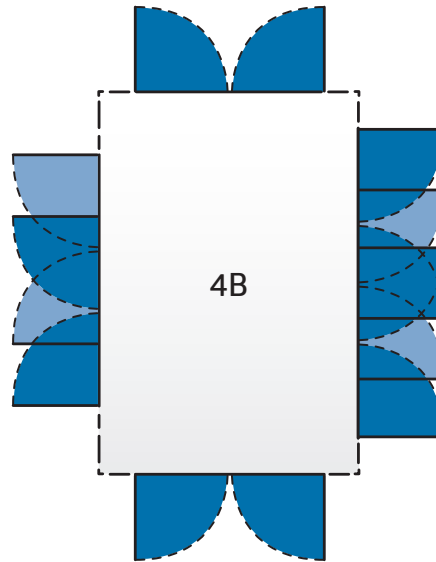
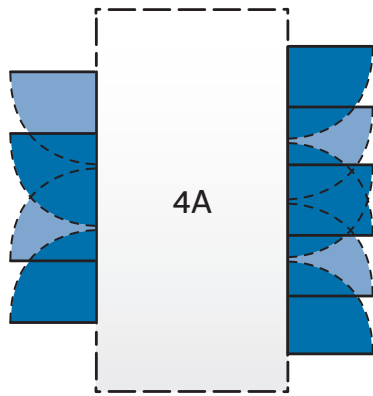

Door Installation Options: Standard Door
HighLine® & Panorama®

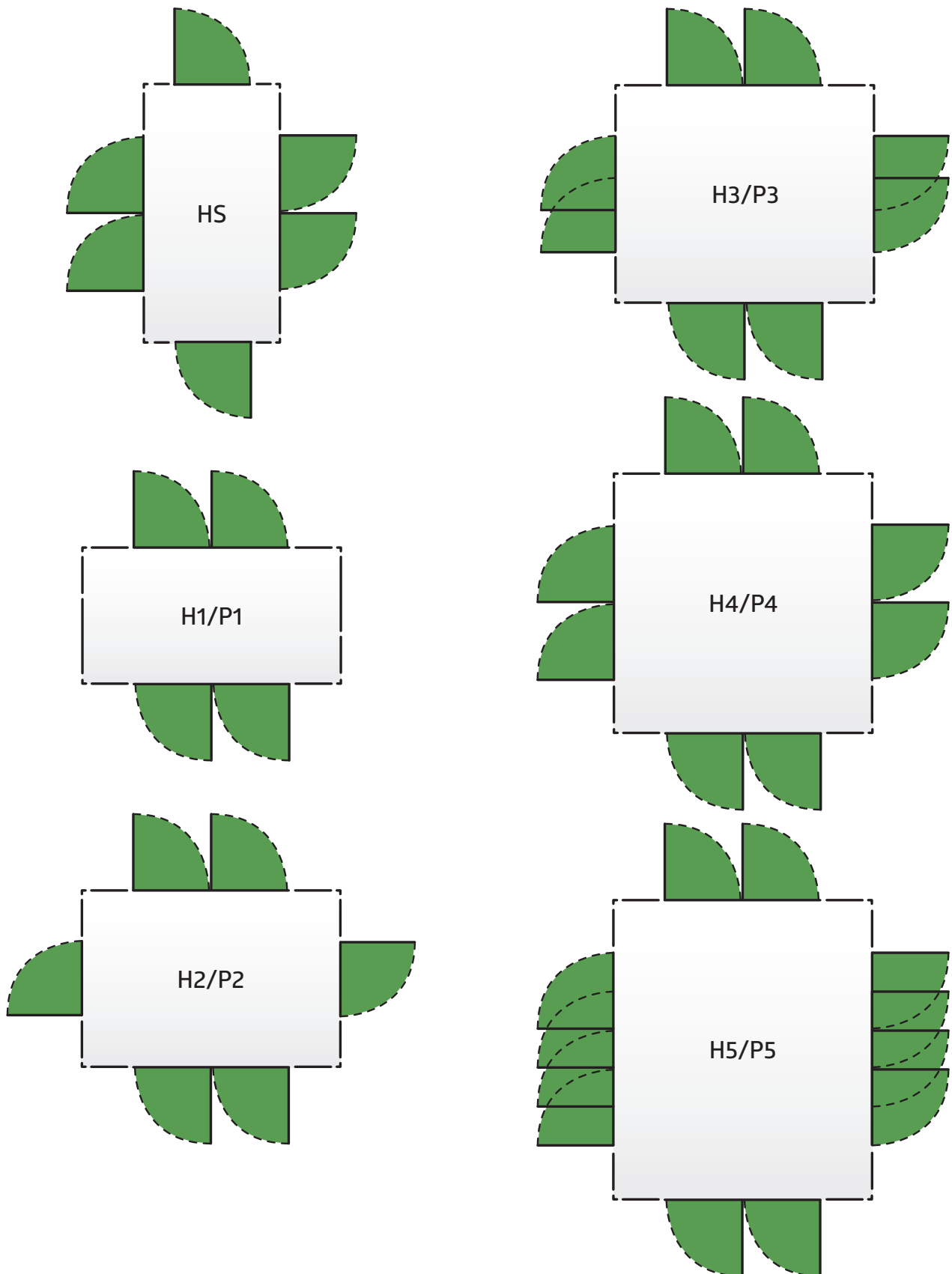

Door Installation Options: Double Door*

HighLine® & Panorama®

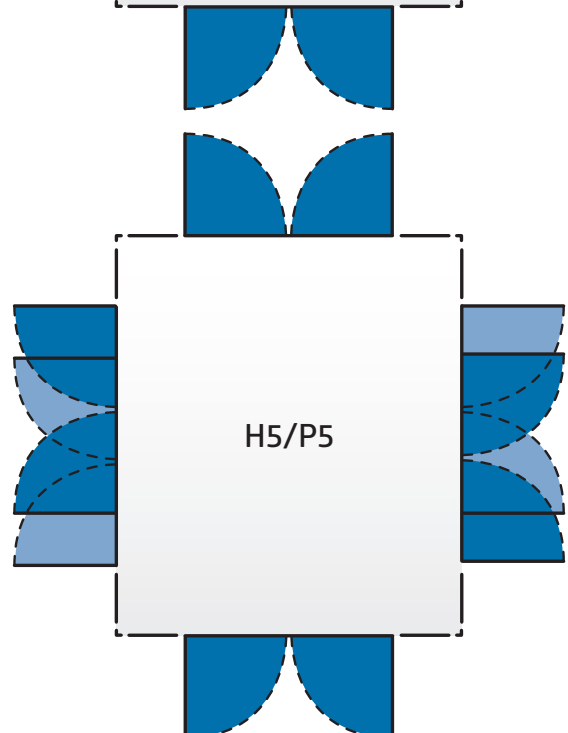
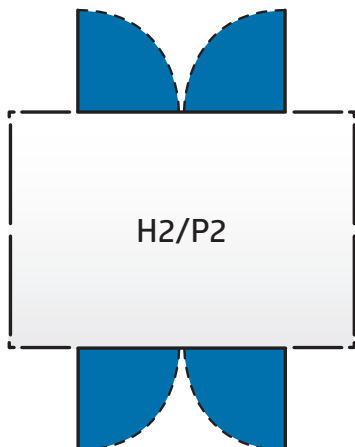
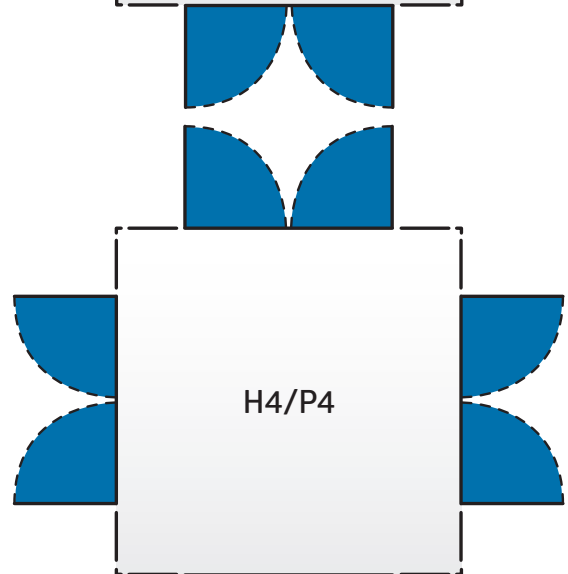
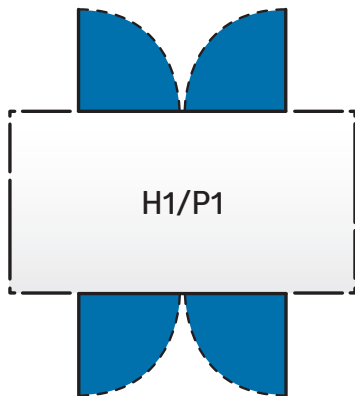
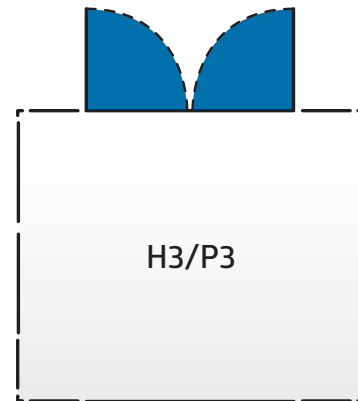
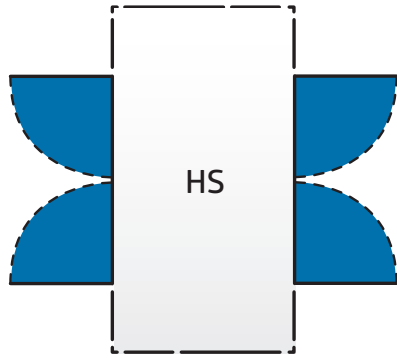

AvantGarde®

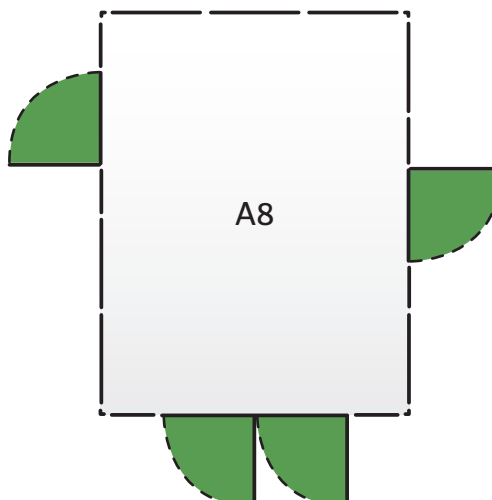
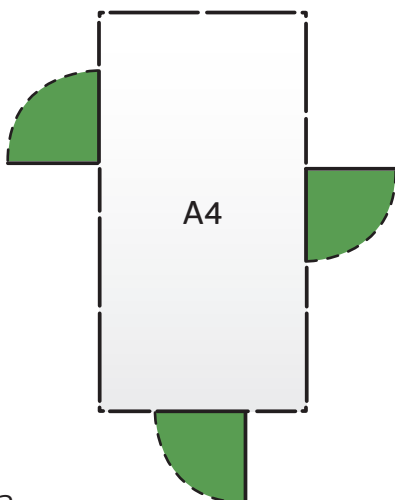
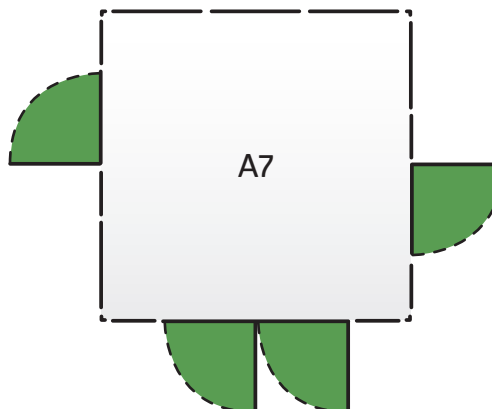
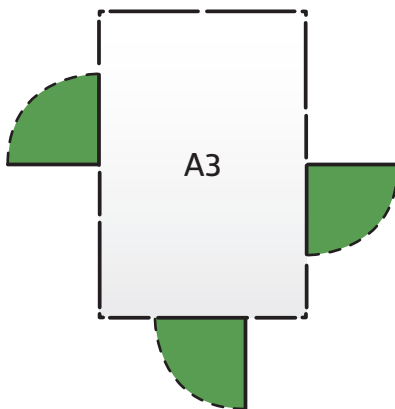
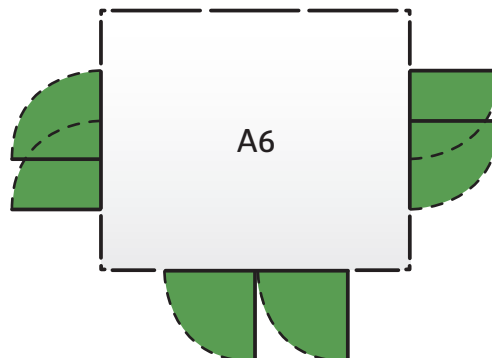
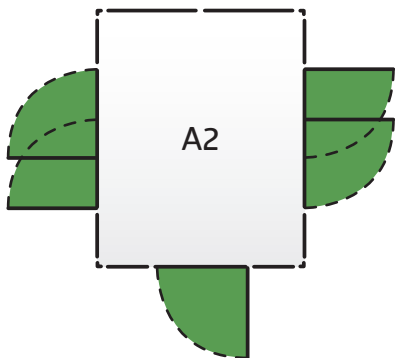
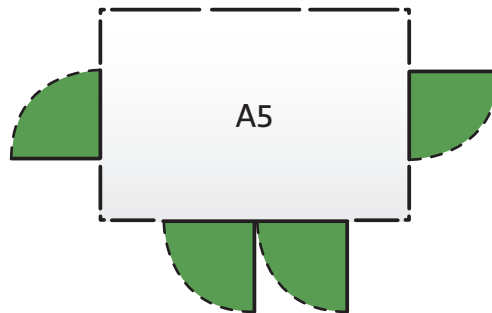
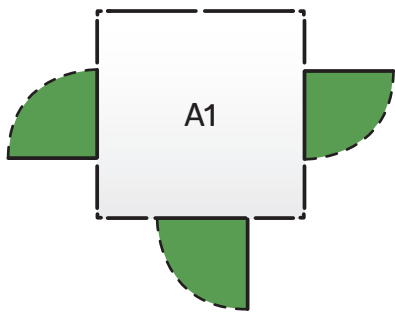

Door Installation Options: Double Door*

AvantGarde®

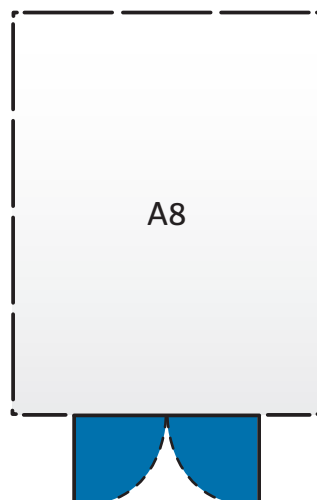
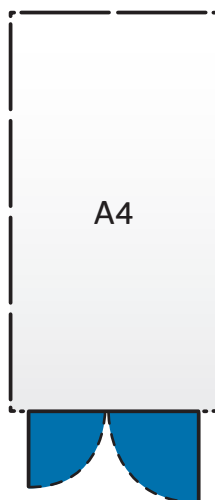
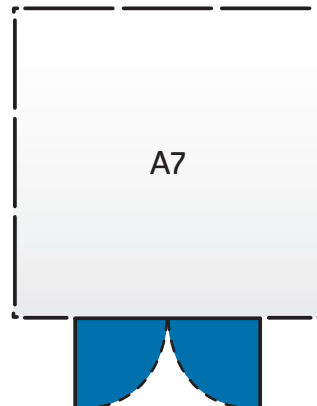
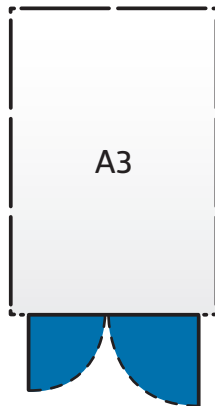
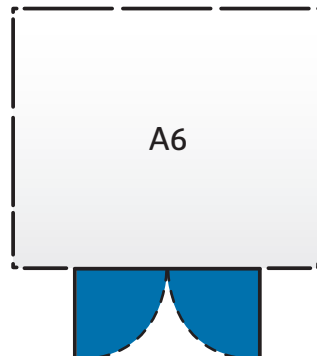
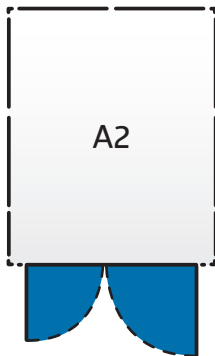
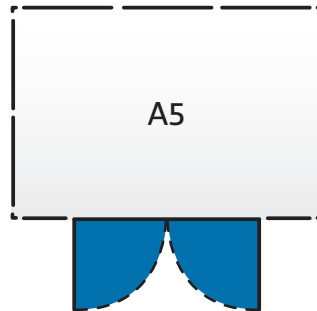
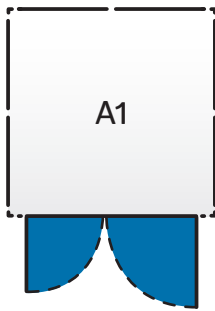

*with door handle on the right door panel.

Door Installation Options: Double Door

Europa

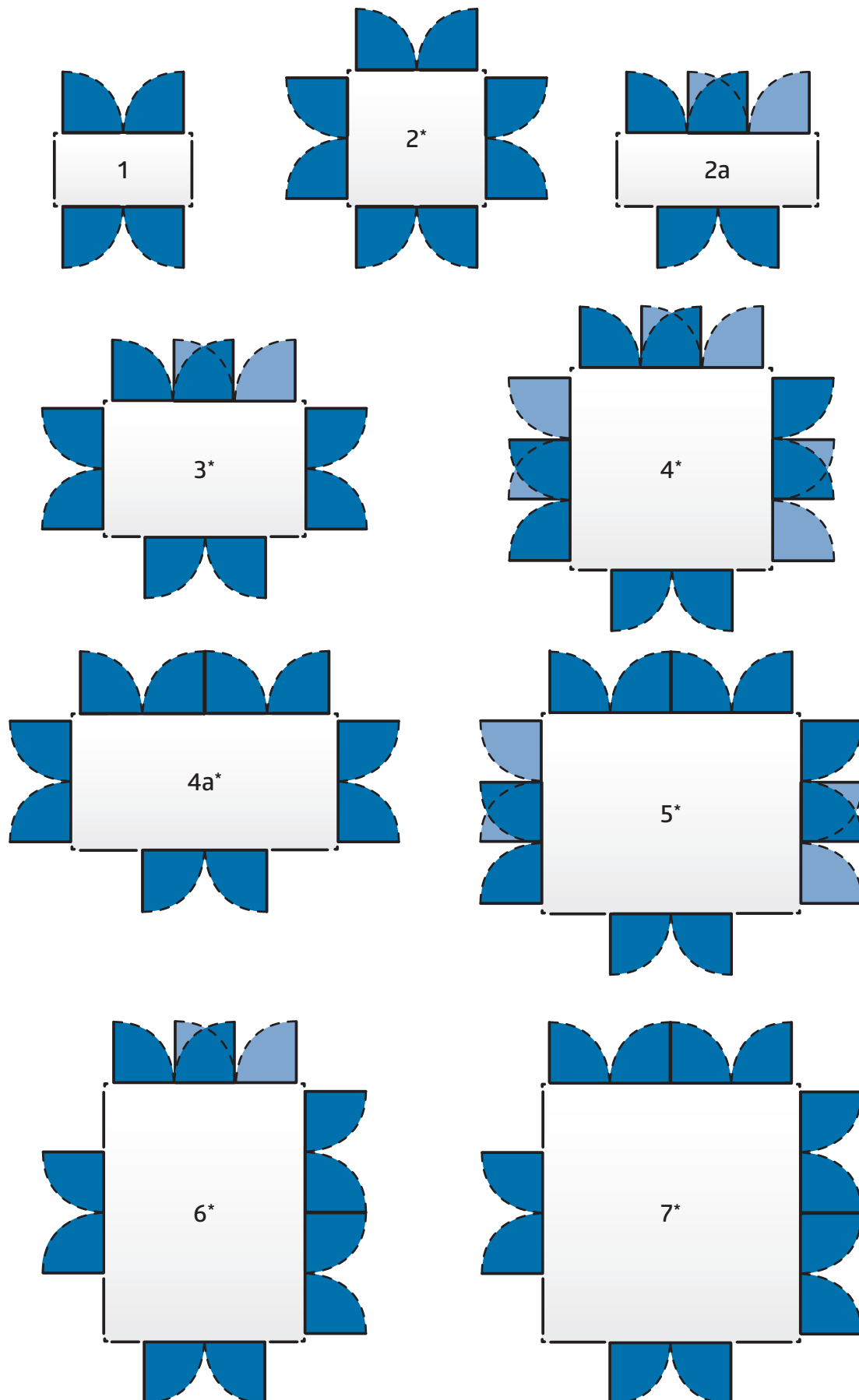

Door Installation Options: Extra Wide Double Door Europa

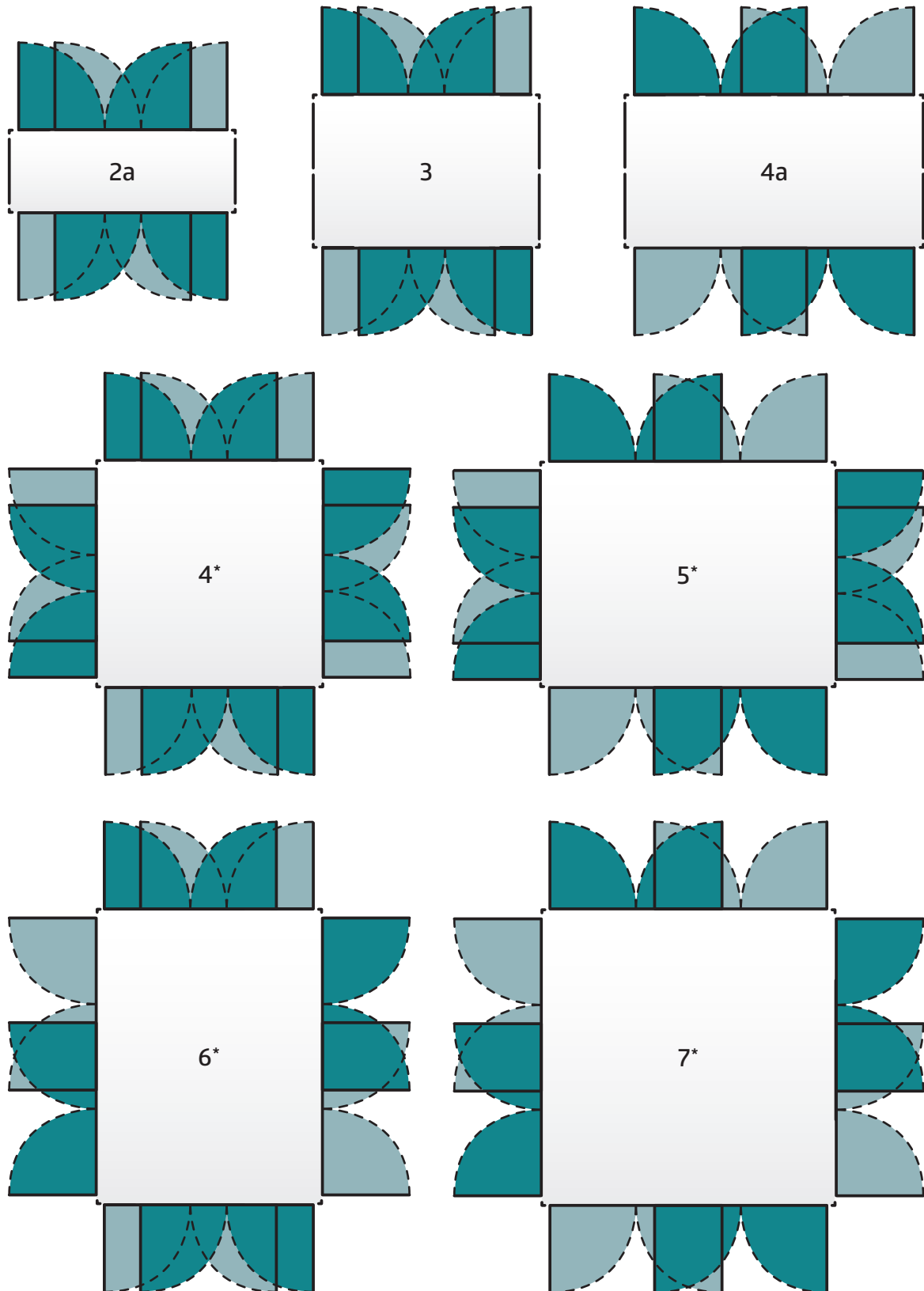



Garden Sheds

Rely on Quality & Longevity



Outdoor Boxes

Outdoor Boxes for the Garden, Patio & etc.



Bicycle Storage

Bicycles, Scooter & etc Safely Stowed



Dustbin Storage

Stylish, Practical & Maintenance Free



Gardening Helpers

Garden Design at its Best



Biohort
stands for
"Life in the
garden"

follow us:

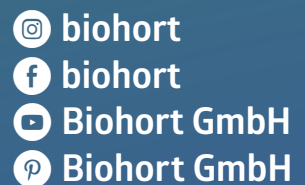

Biohort GmbH
Pürnstal 43, 4120 Neufelden,
Austria
Tel: +43-7282-7788-0, Fax Ext.: 190
E-mail: office@biohort.at
Web: www.biohort.com

Subject to technical changes and
printing errors.